

Templates

These templates are for the projects featured in *Playing with Pop-Ups* by Helen Hiebert, which appear on the following pages in the book. Print them at 100% and follow the instructions for assembly as shown.

Contents

Pop-Up Paper Earrings, page 39

Tower of Babel, page 41

Pop-Up City Skyline, page 47

Pop-Up Valentine, page 51

Pop-Up Robot, page 53

Bloodroot Plant, page 55

Pop-Up Dragon, page 57

Pop-Up First Bank, page 60

Pop-Up Tent and Pyramid, page 65

Carousel Pop-Up Book, page 68

Tunnel Book, page 76

Puppy Puppet, page 81

Pull-Tab Rib Cage, page 83

Volvelle with Six Slots, page 85

Pop-Up Paper Earrings, page 39

©Helen Hiebert

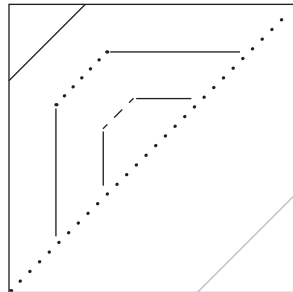
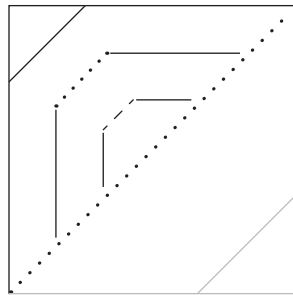

KEY

.....

Valley

Mountain

Cut _____

Tower of Babel, page 41

©Elod Beregszaszi

KEY

.....

Valley ———

Mountain ———

Cut ———

3 Template: 3 floors

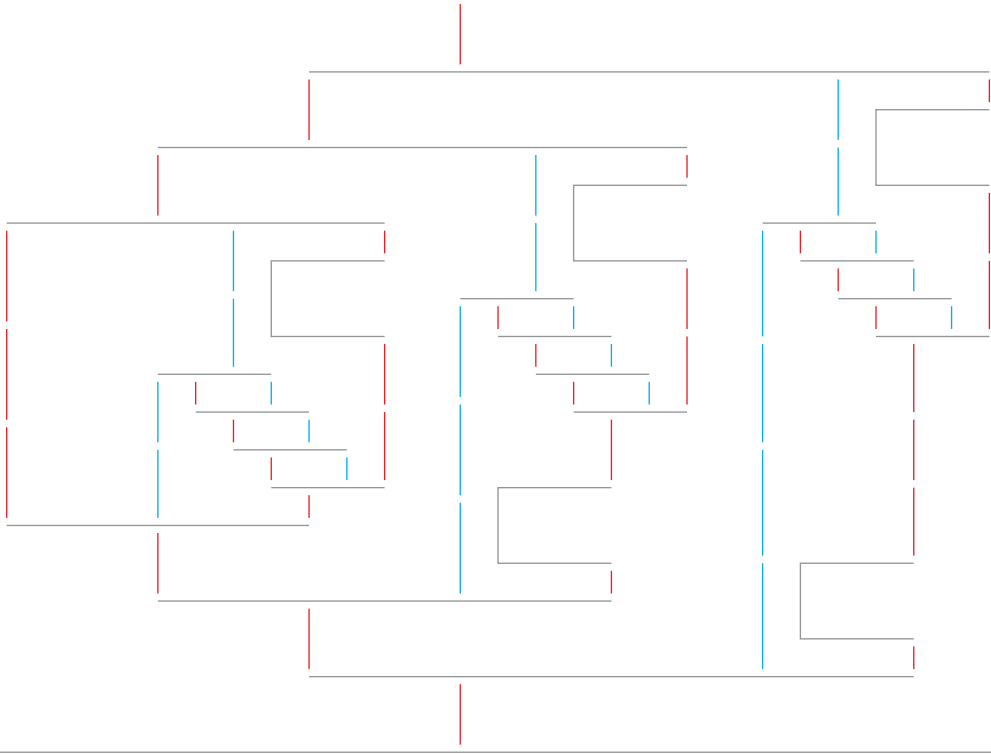

2 Template: 2 floors

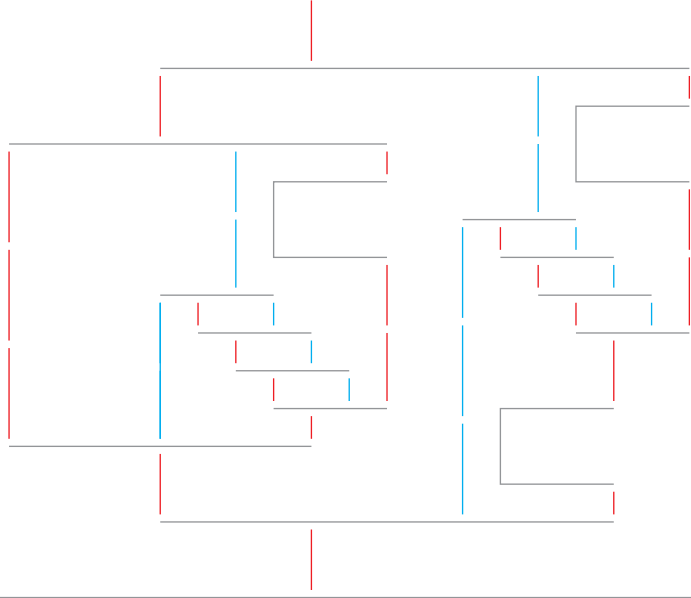

1 Template: 1 floor

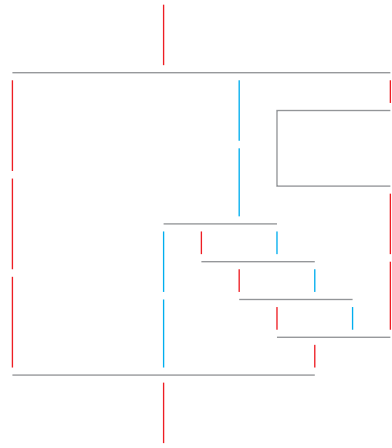

Pop-Up City Skyline, page 47

©Paul Johnson

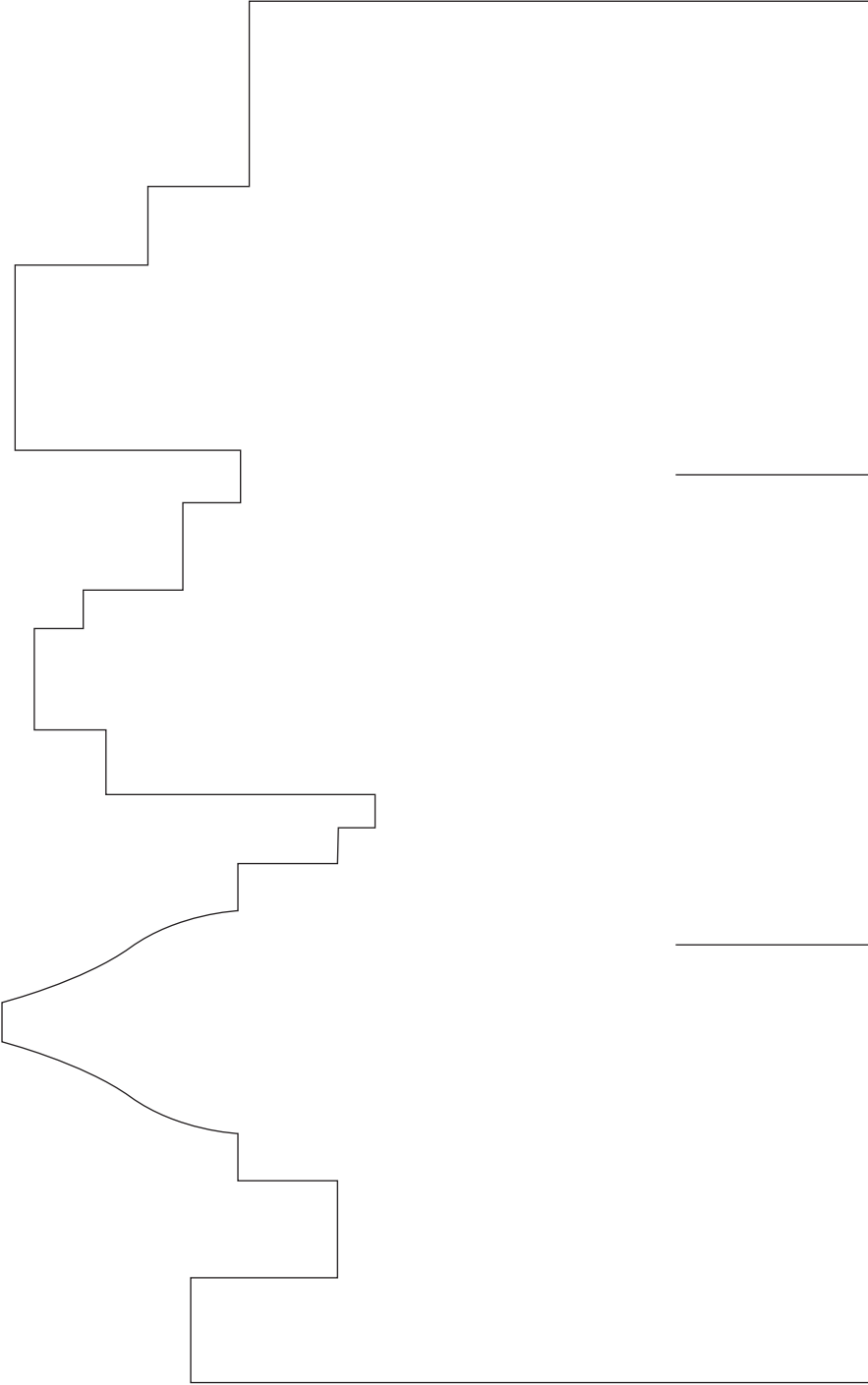
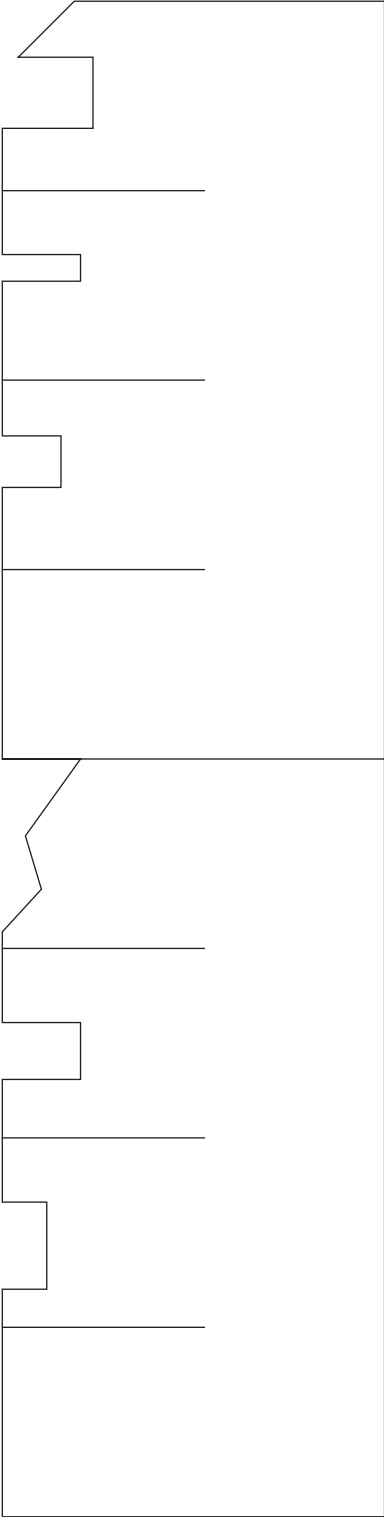

Pop-Up City Skyline, page 47

©Paul Johnson

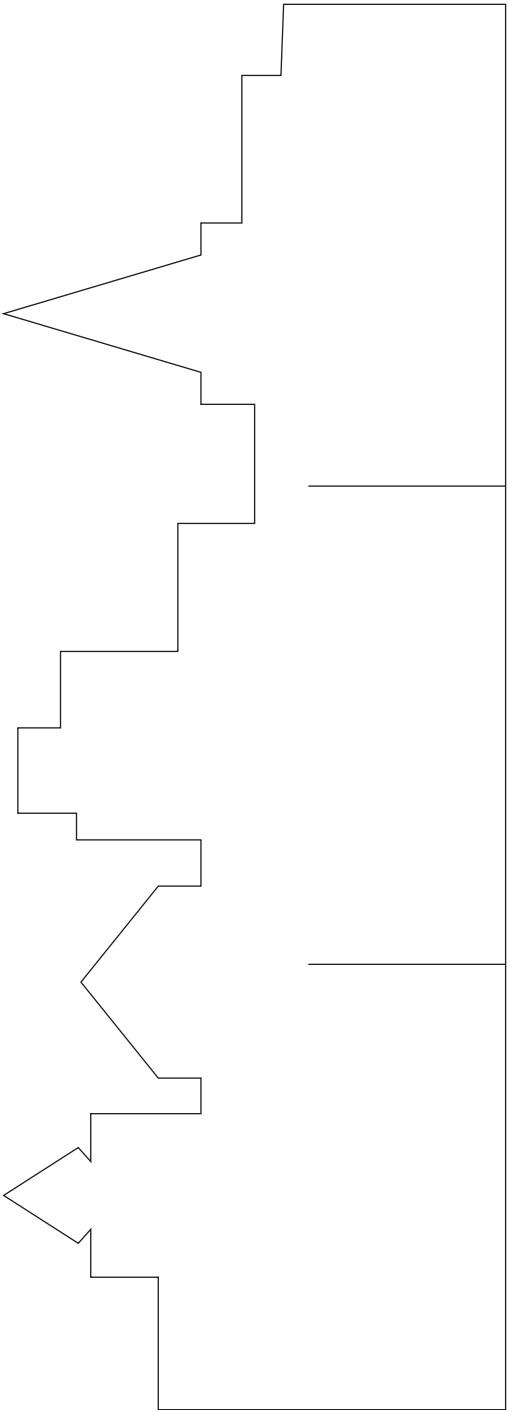
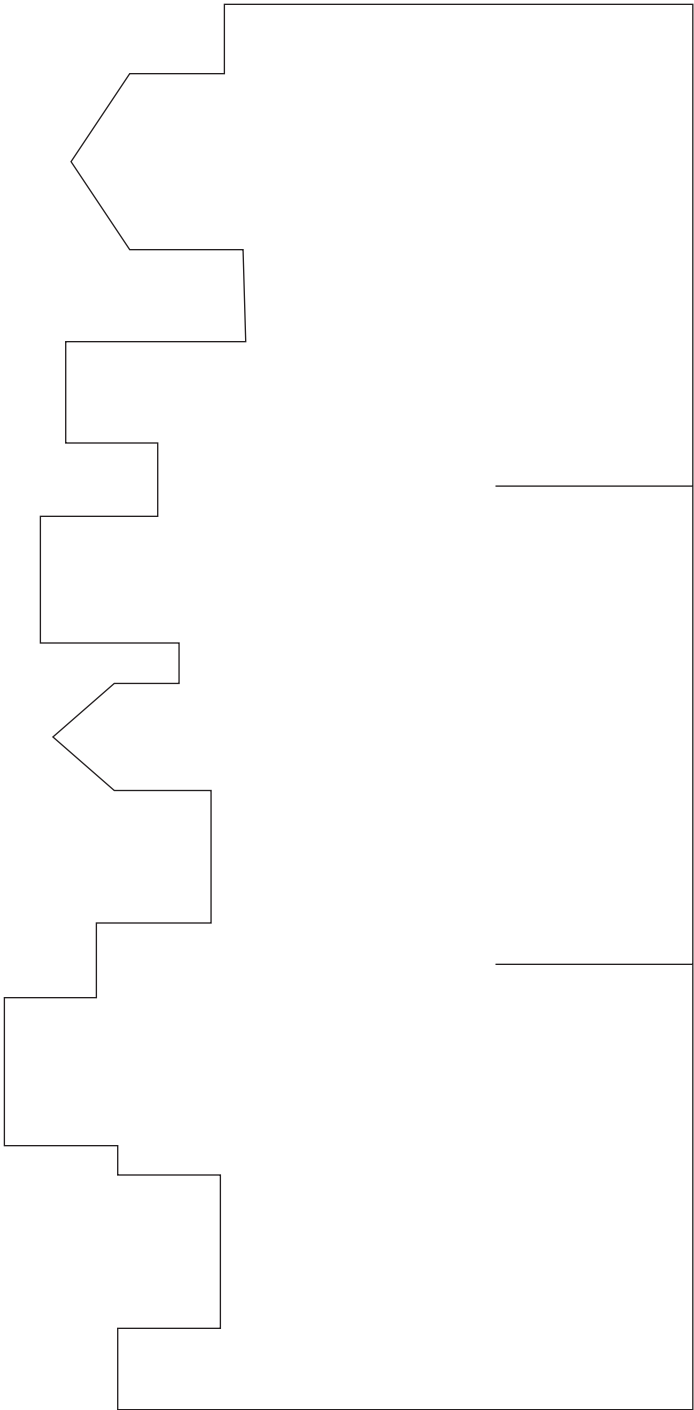

Pop-Up Valentine, page 51

©Kyle Olman

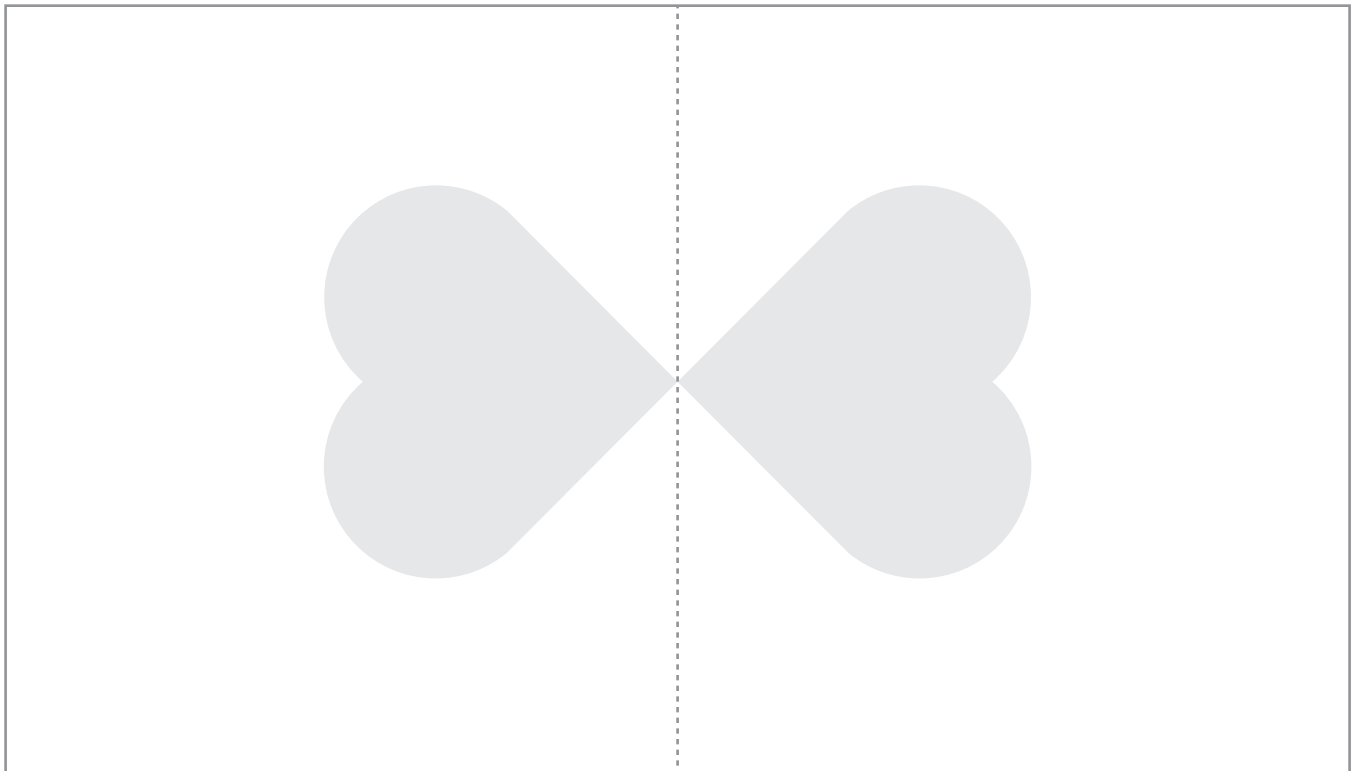
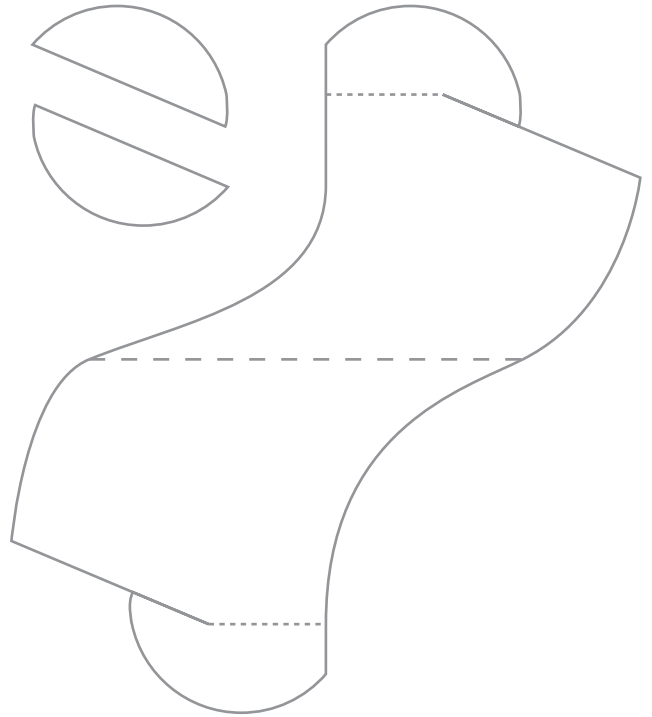
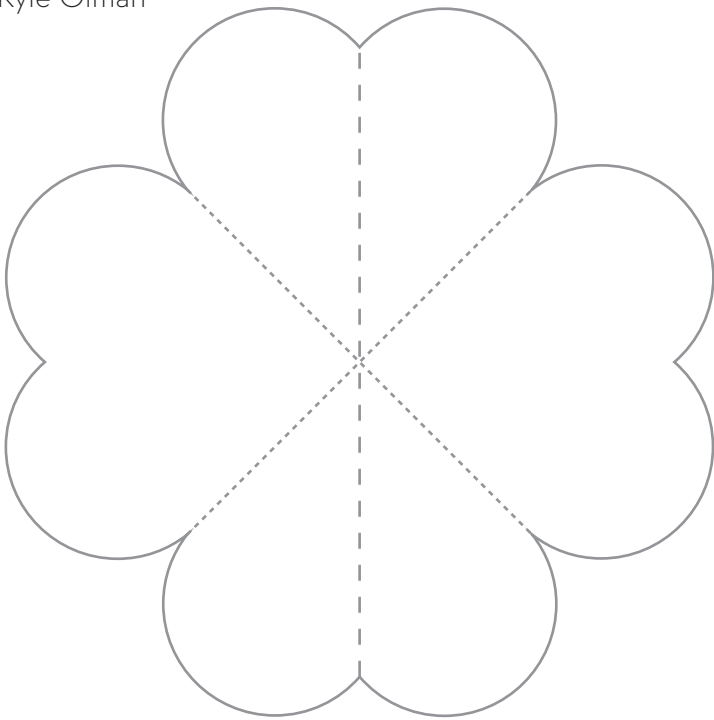

KEY

.....

Valley

Mountain

Cut _____

Pop-Up Robot, page 53

©Sam Ita

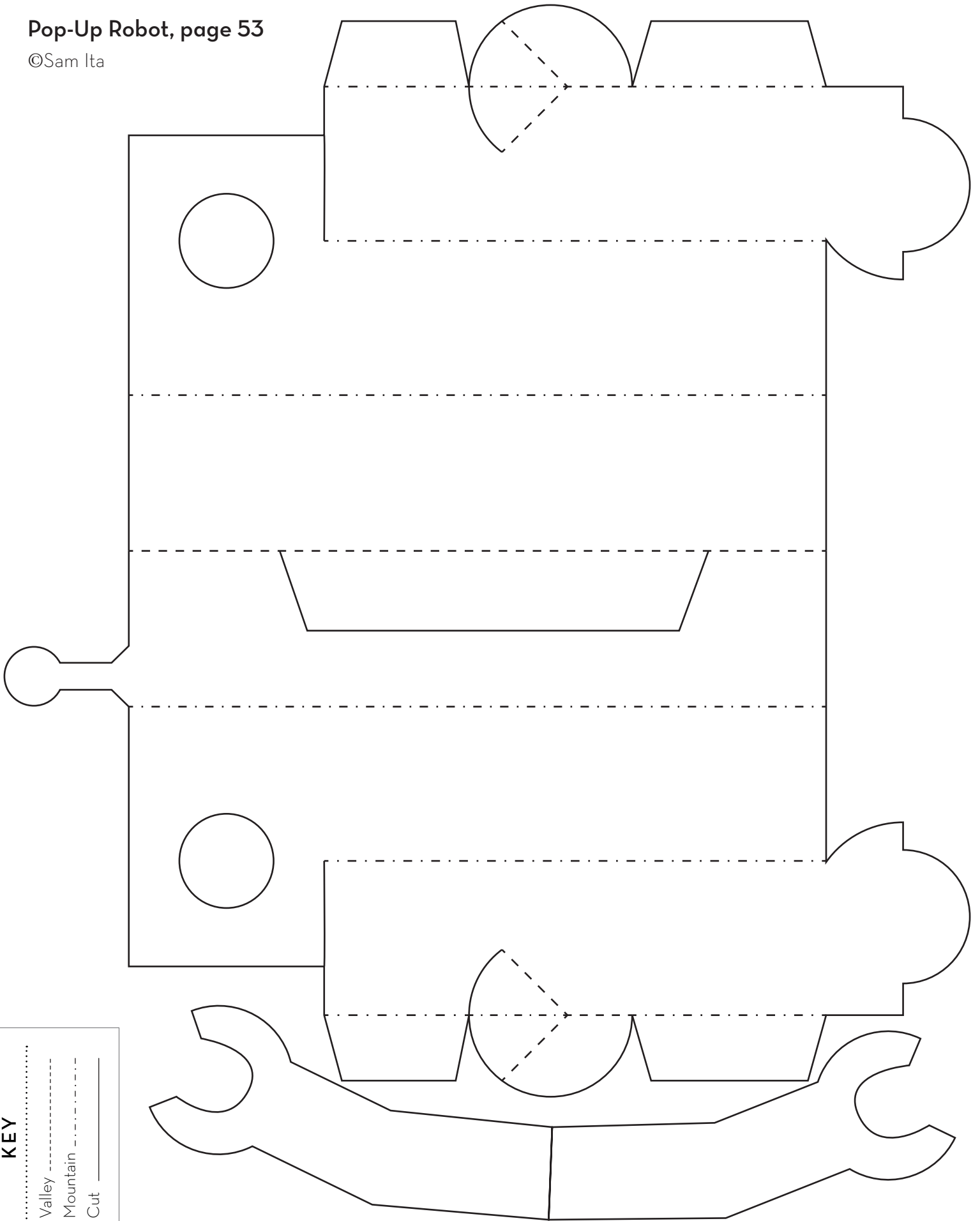

KEY

-
- Valley - - - - -
- Mountain -
- Cut ———

Bloodroot Plant, page 55

©Shawn Sheedy

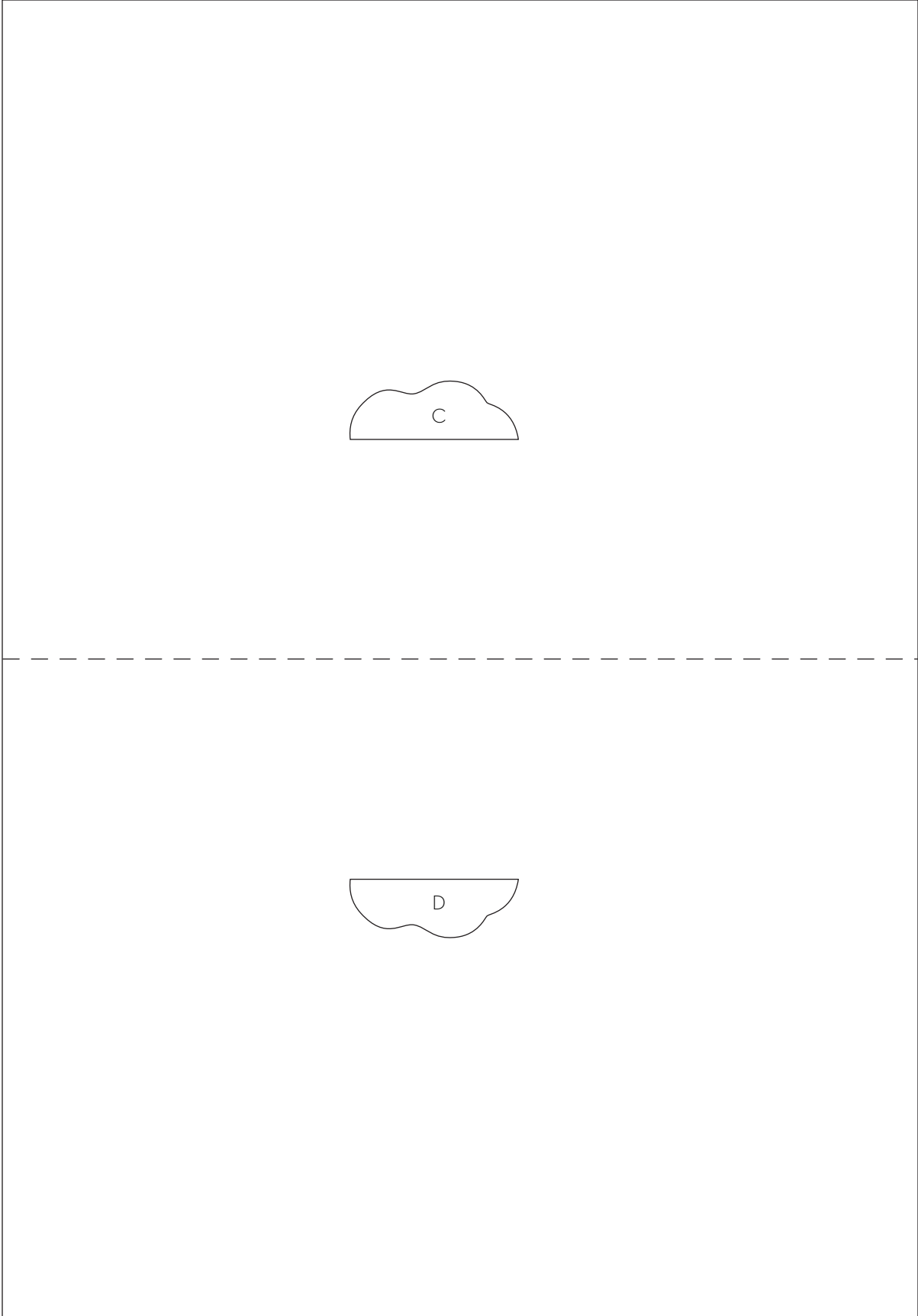

Bloodroot Plant, page 55

©Shawn Sheedy

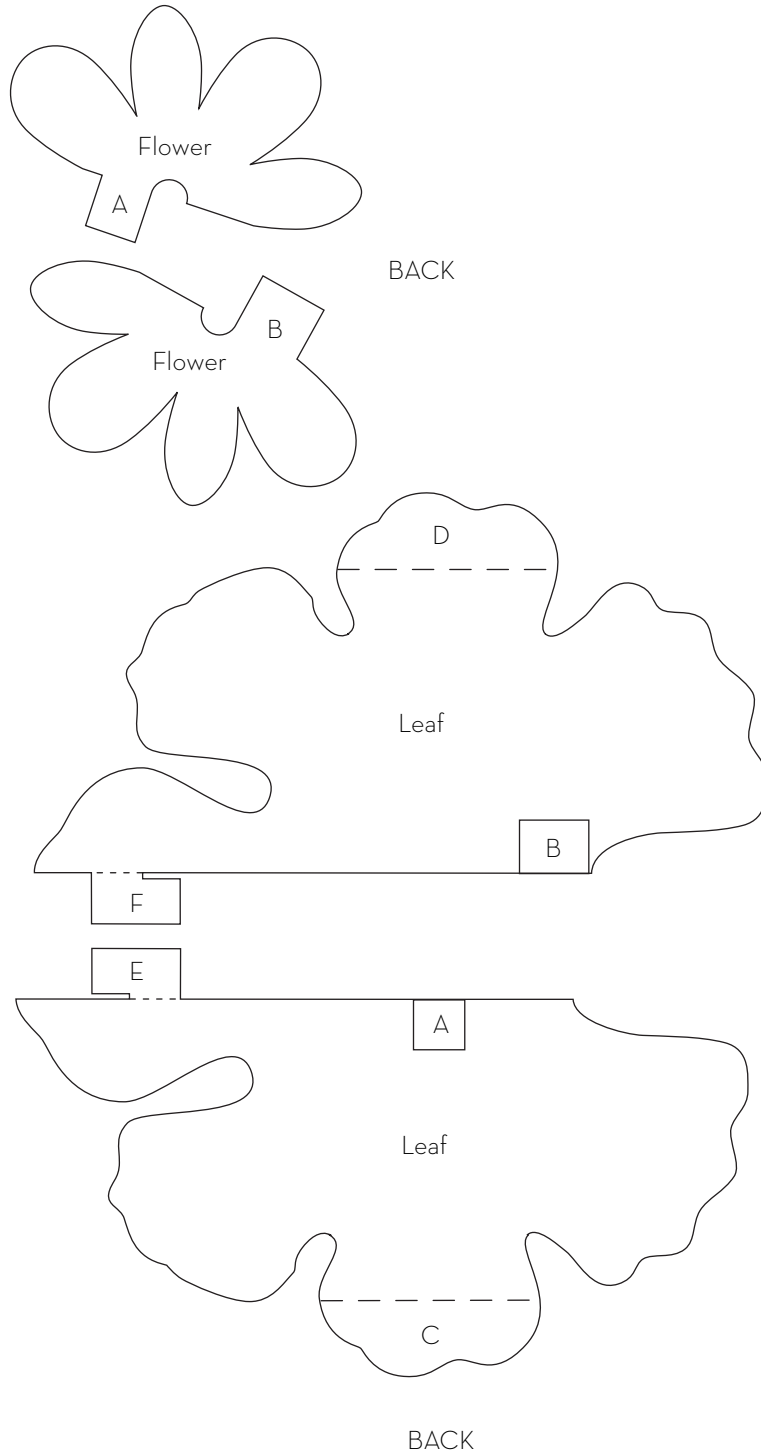

Pop-Up Dragon, page 57

©Bruce Foster

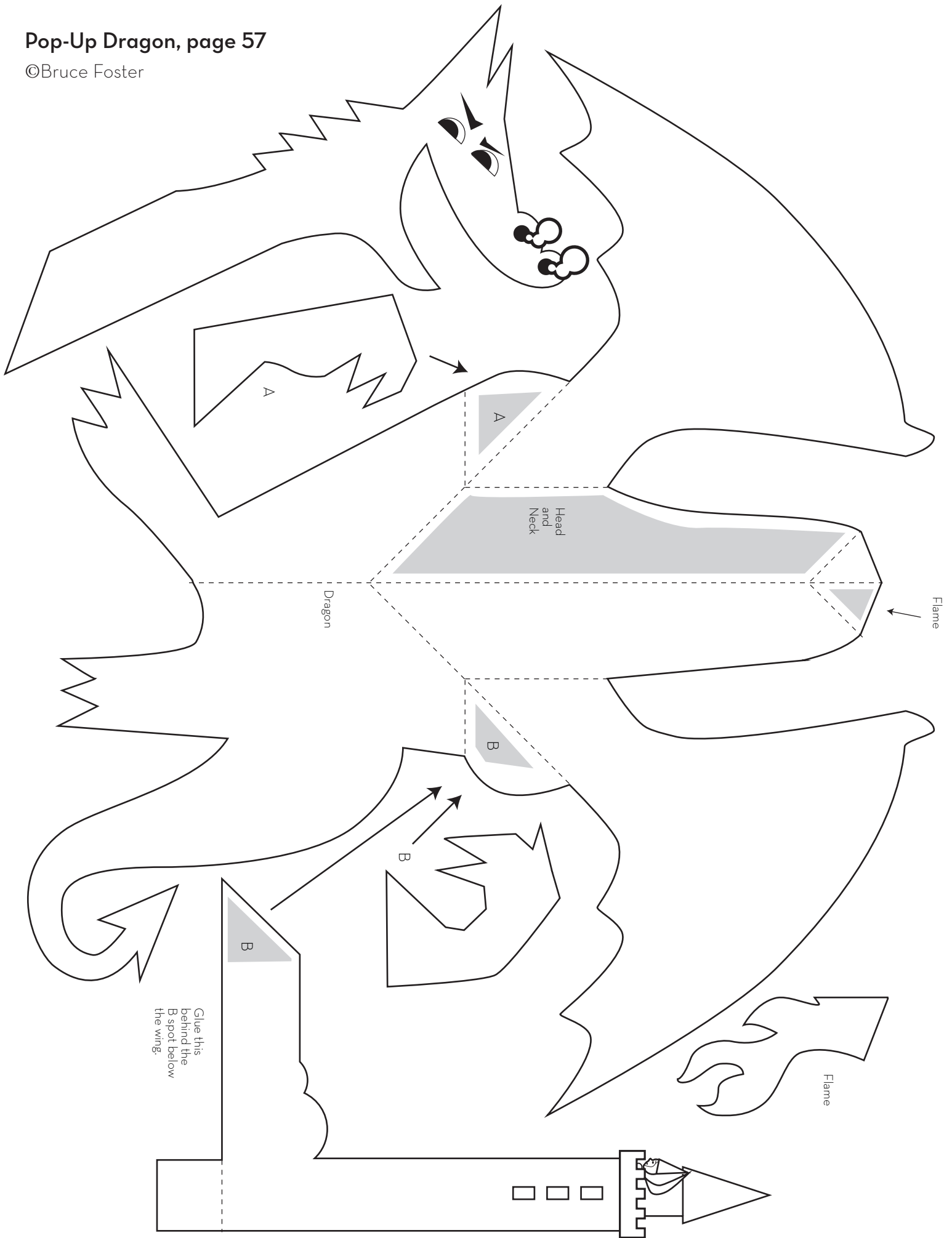

Base card front

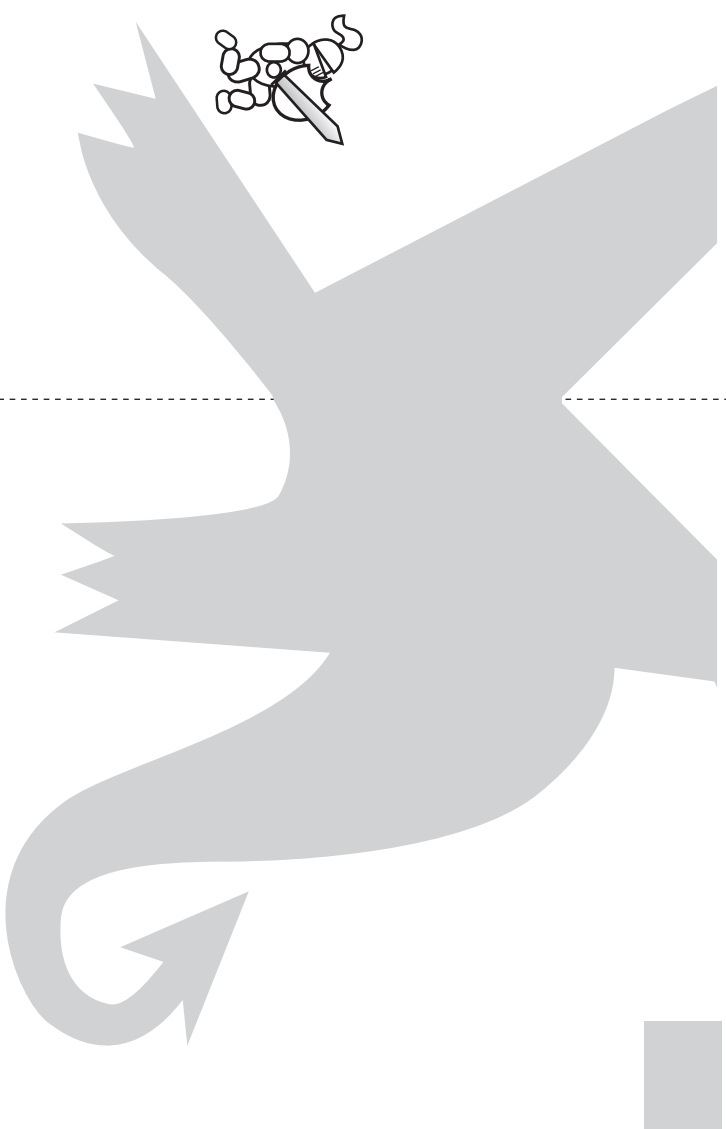

Base card back

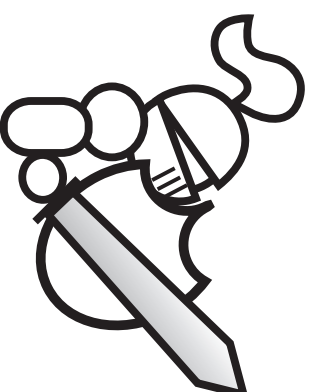
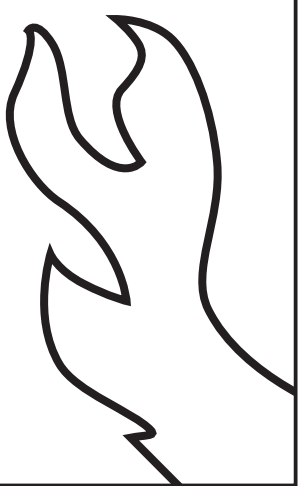

Pop-Up Dragon
(variation), page 57
©Bruce Foster



Glue this BEHIND the B spot below wing.

Head and Neck

Flame

A

A

B

B

B

Flame



FIRE-BREATHING DRAGON!

Base card back

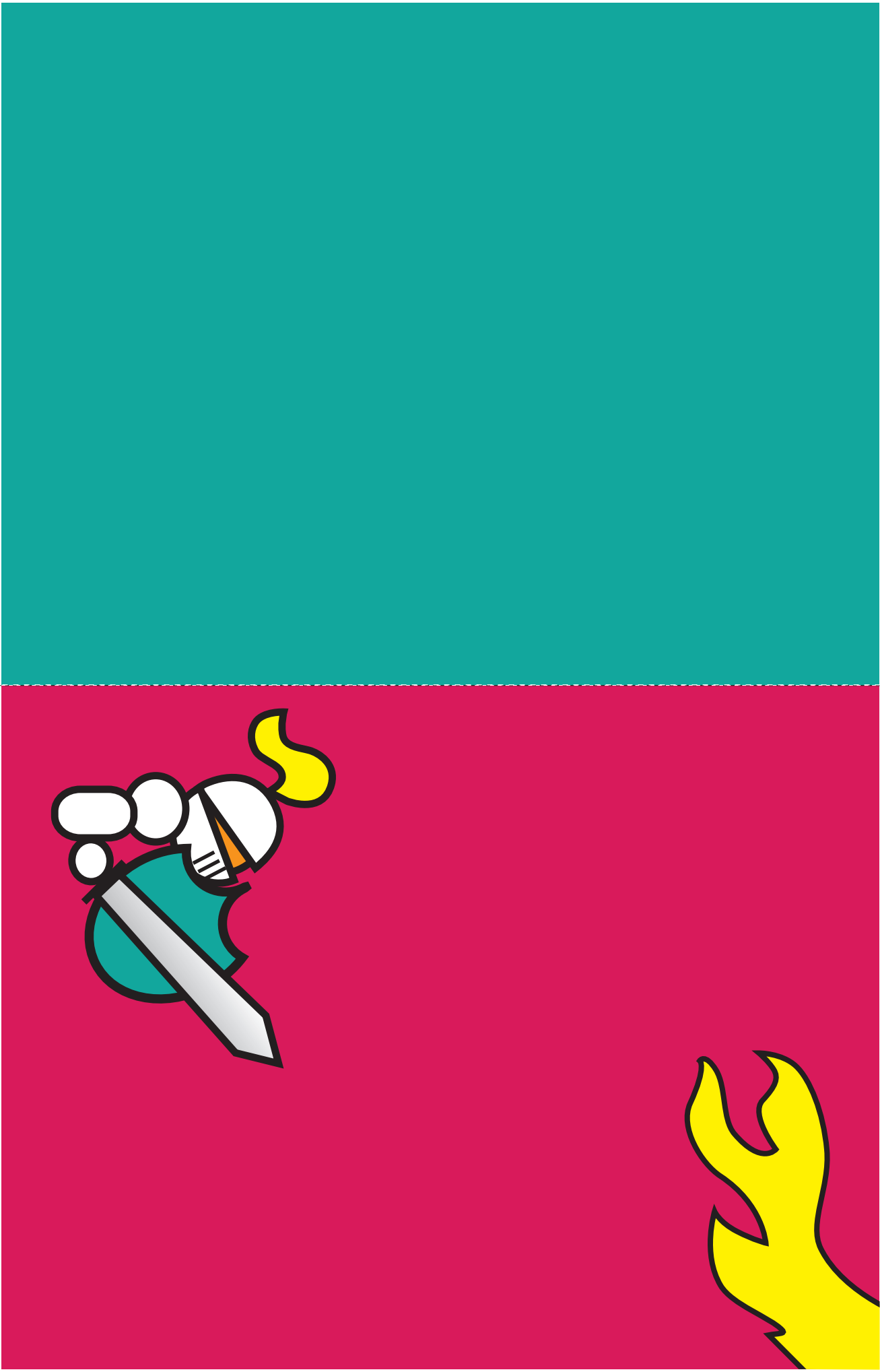

Top Layer



Middle Layer





Pop-Up Tent and Pyramid, page 65

©Carol Barton

Pop-Up Tent

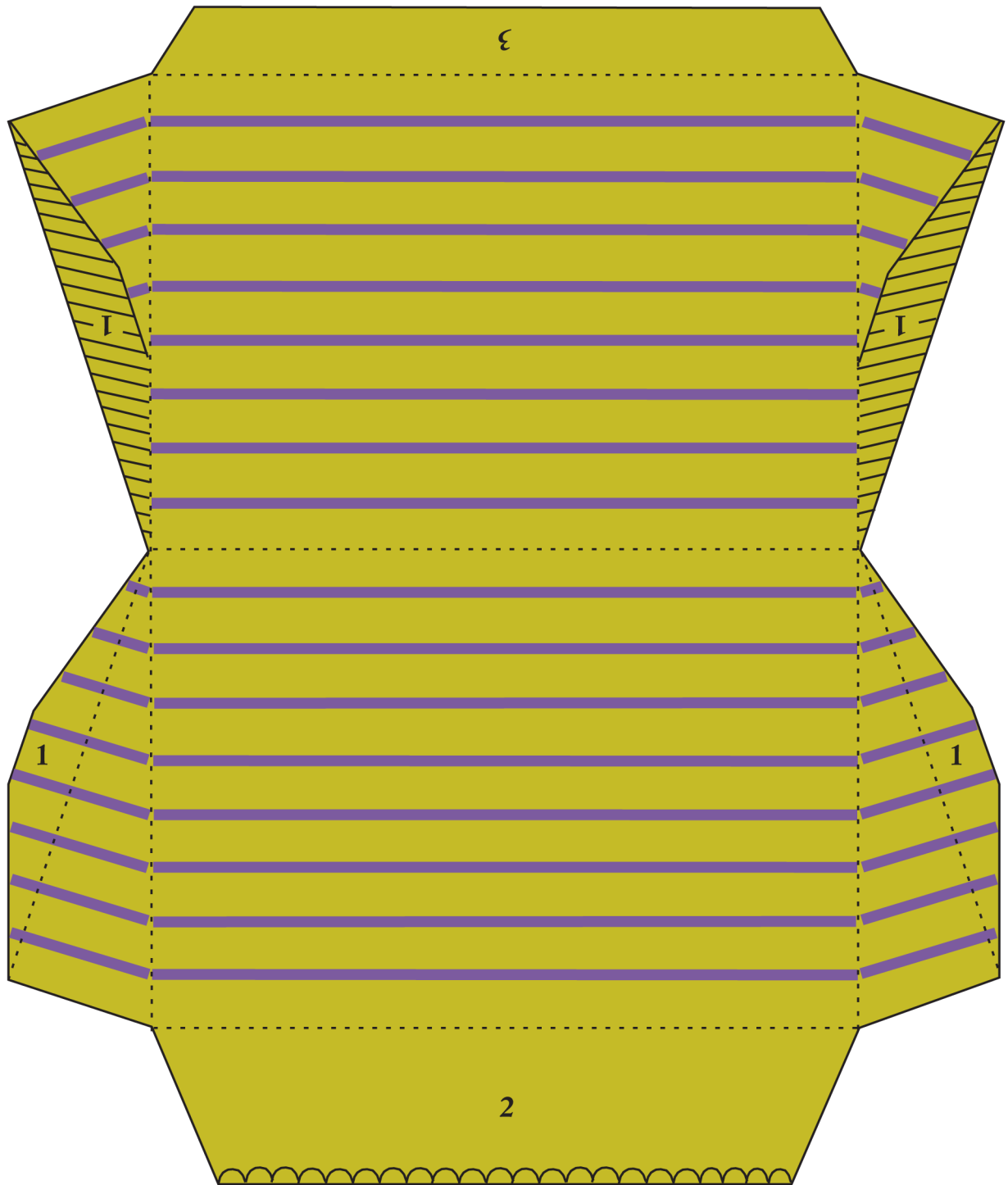

KEY

.....

Fold -----

Glue /////
////

Pop-Up Pyramid

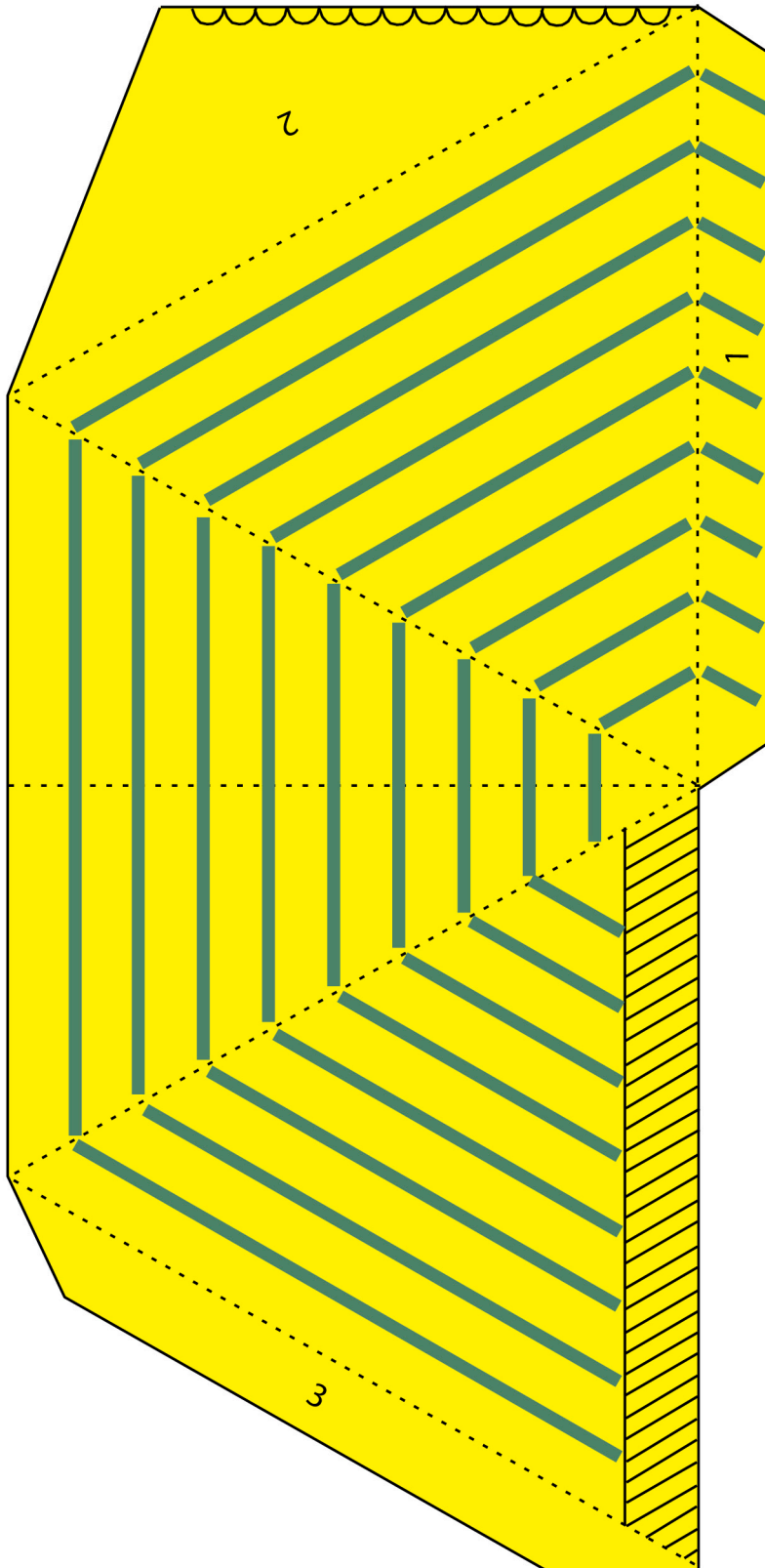

KEY

Fold -----

Glue /////

Bedroom Walls

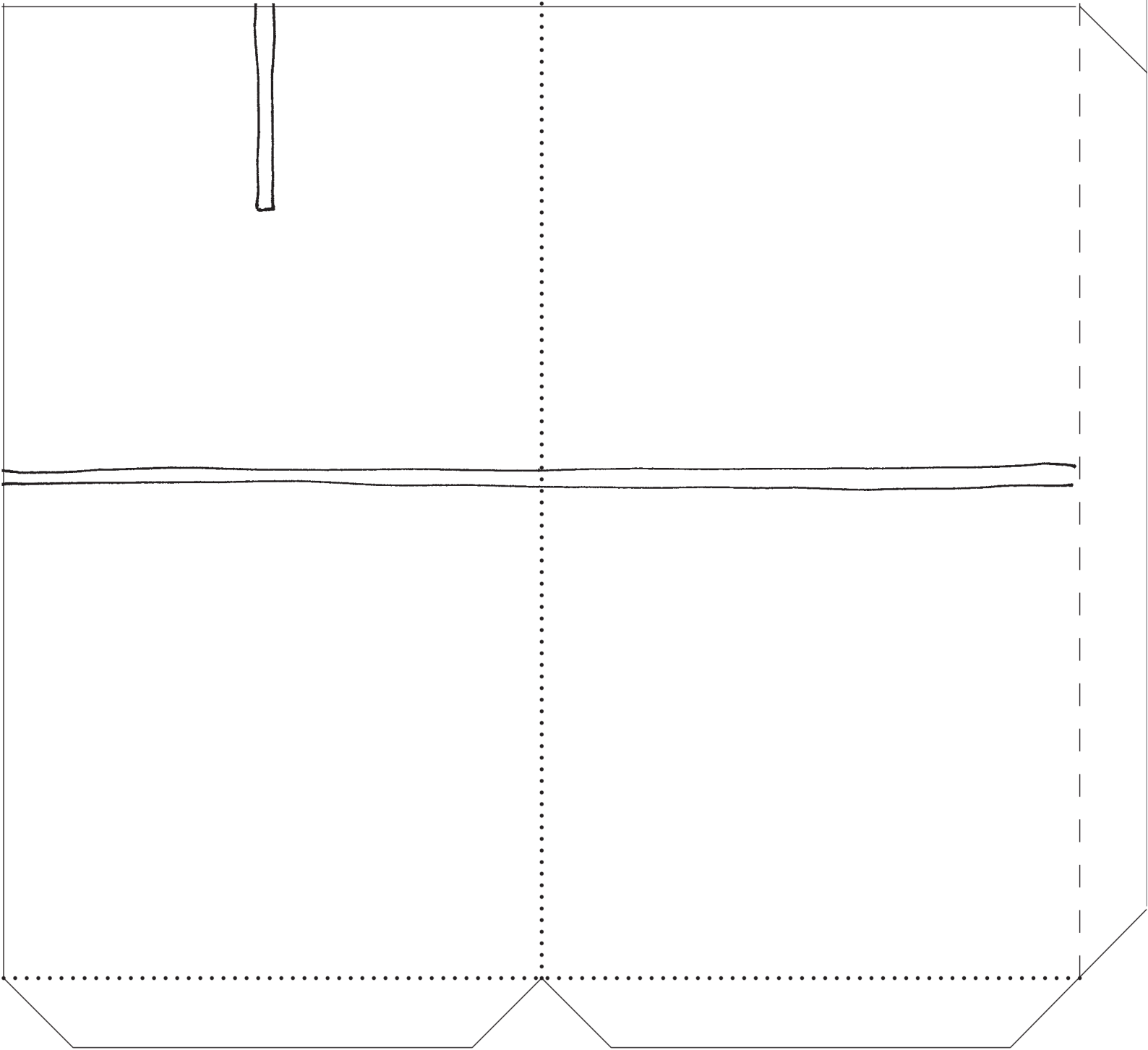

KEY

.....

Valley

Mountain - - - -

Floor

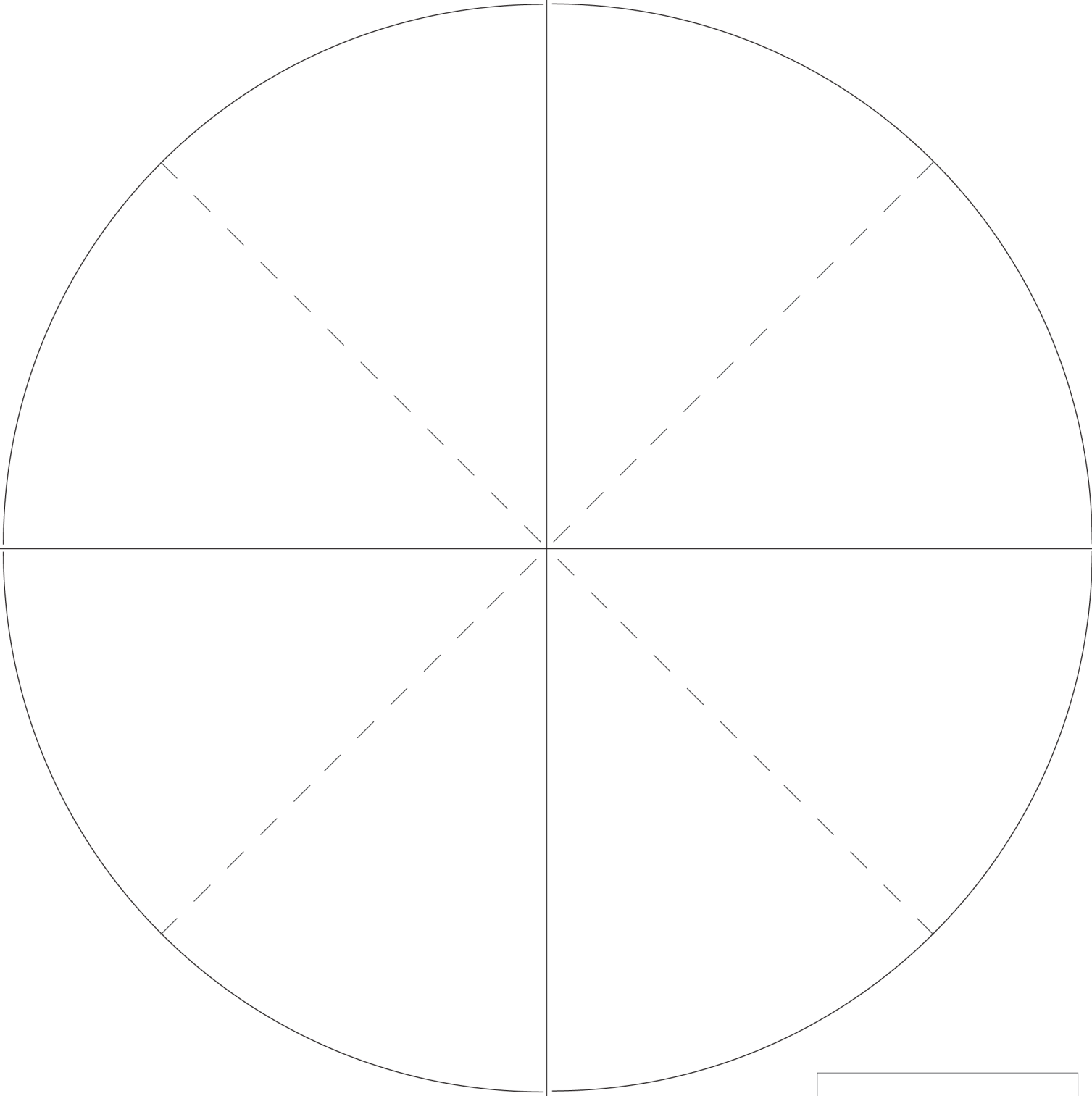

KEY

.....

Valley

Mountain - - - -

Kitchen Walls

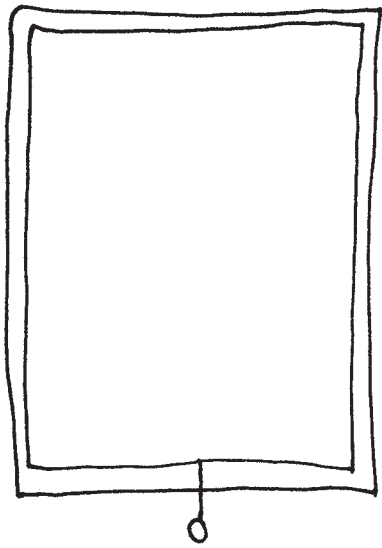

KEY

.....

Valley

Mountain - - - -

Outdoor Grill Walls

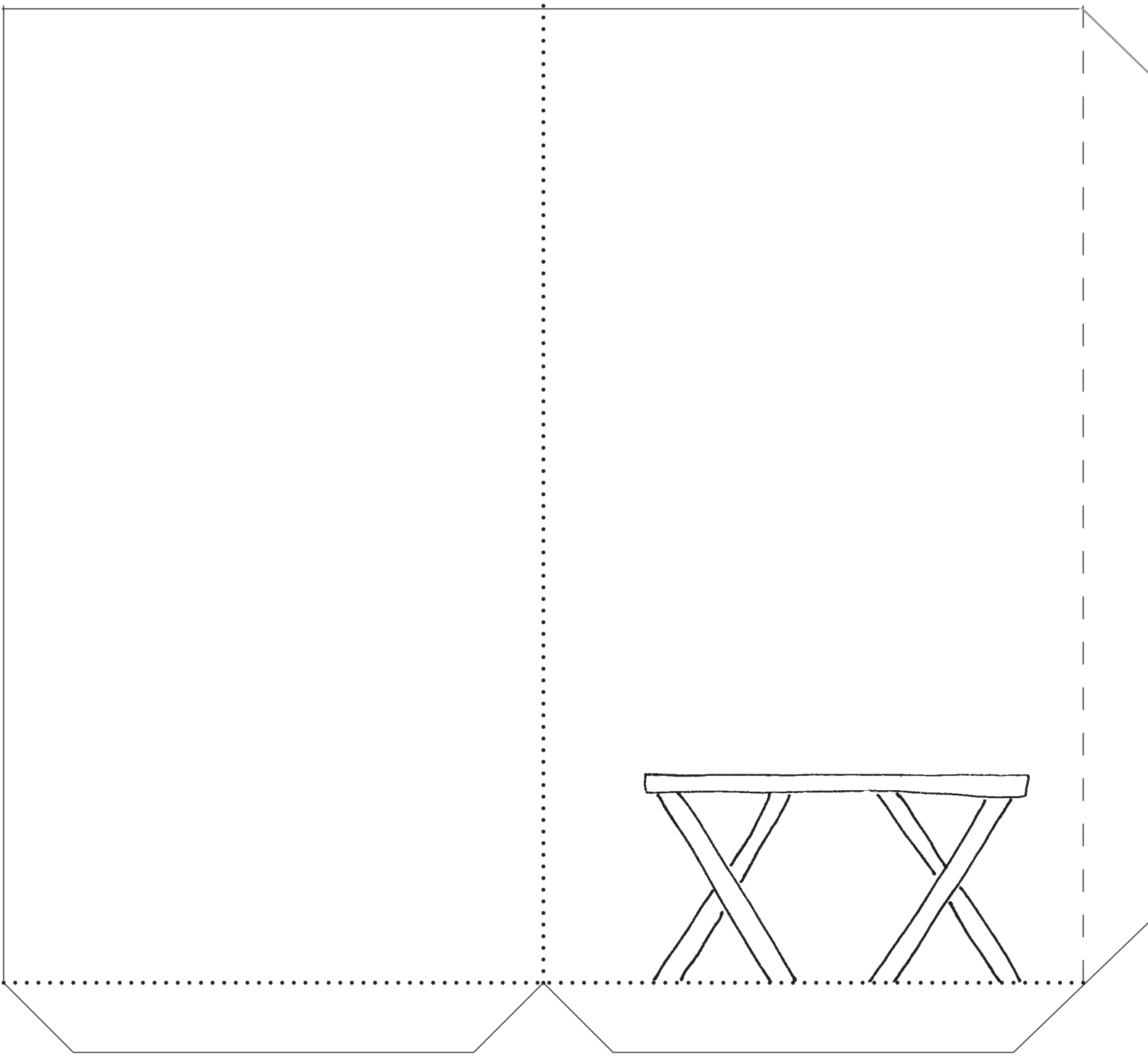

KEY

.....

Valley

Mountain - - - -

Outdoor Laundry Walls

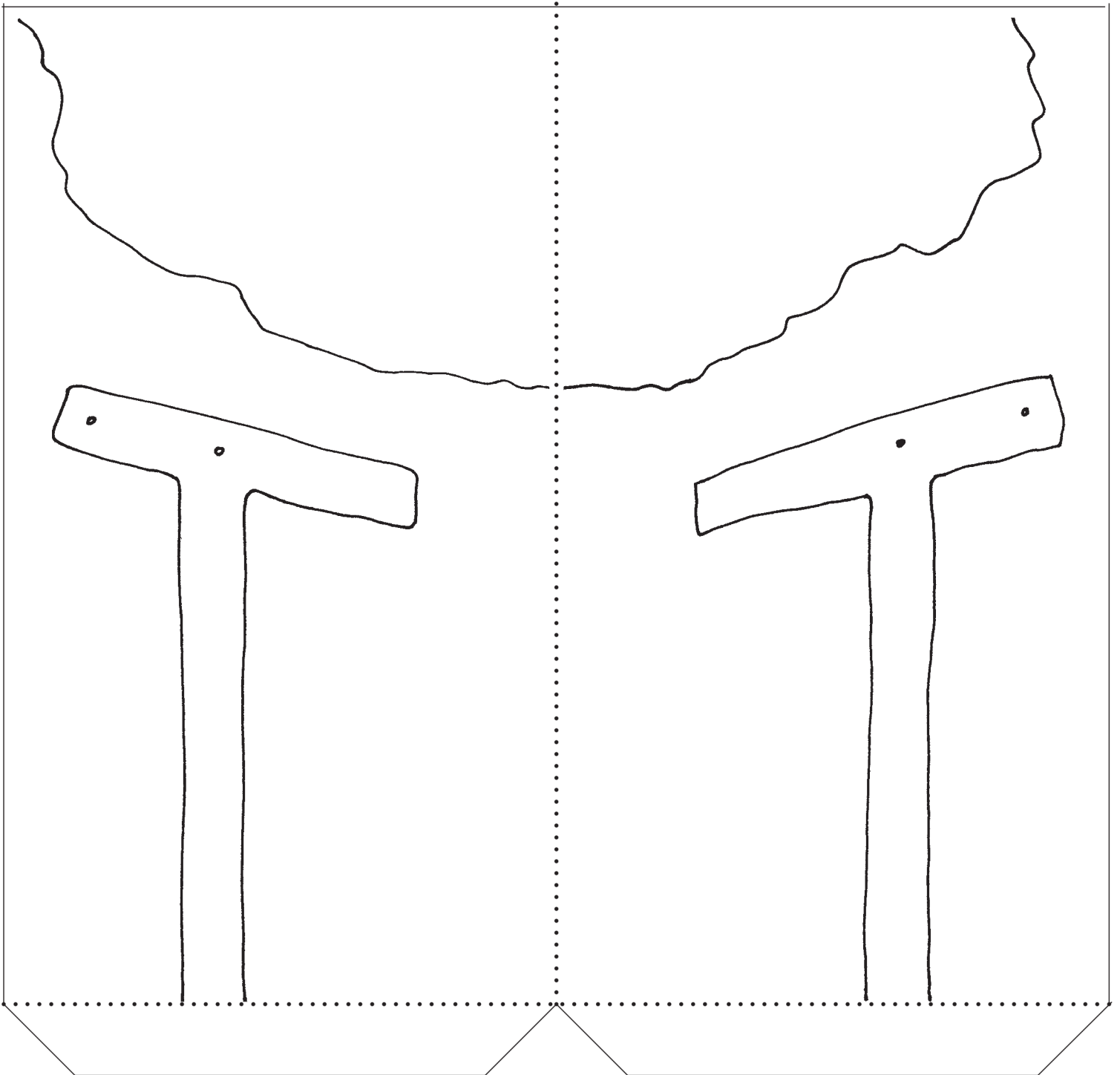

KEY

.....

Valley

Mountain - - - -

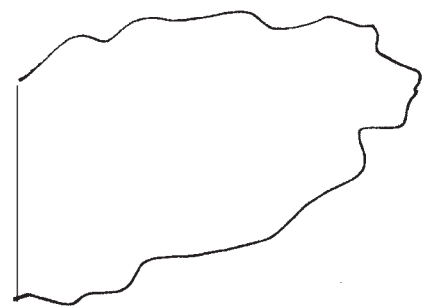
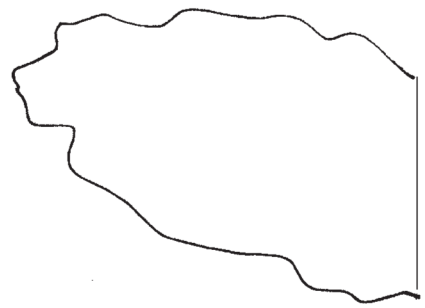
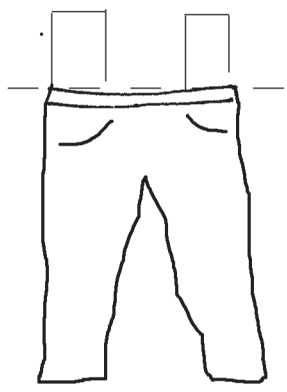
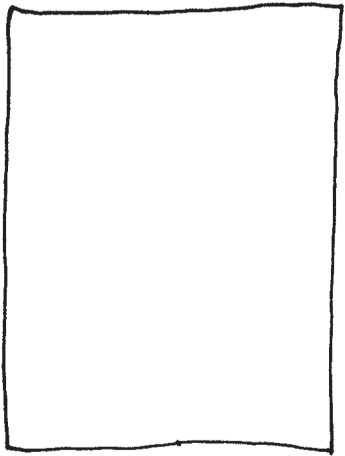
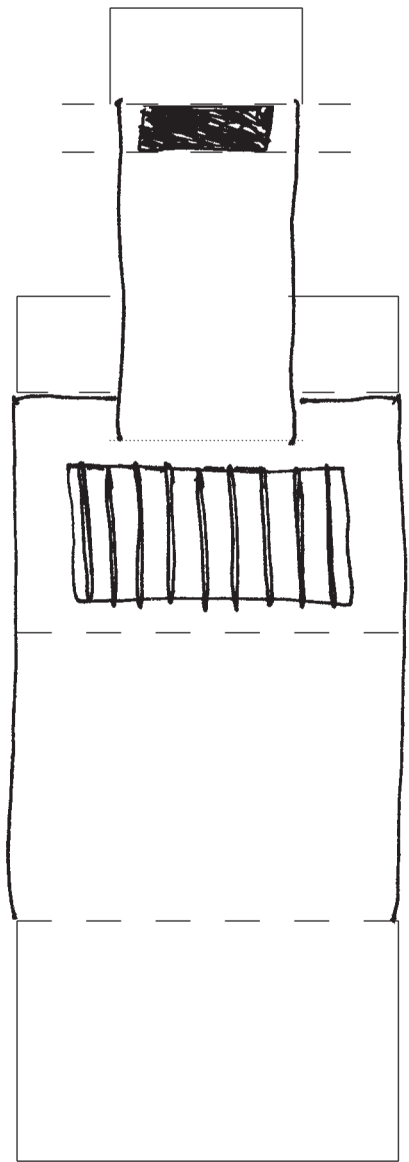
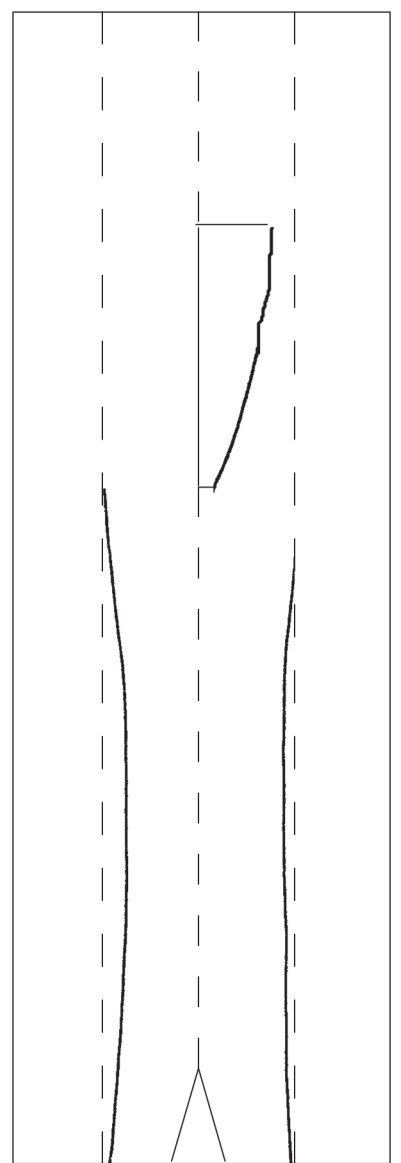
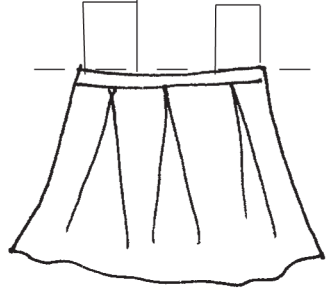
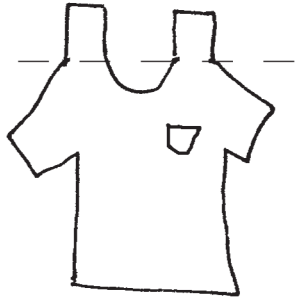
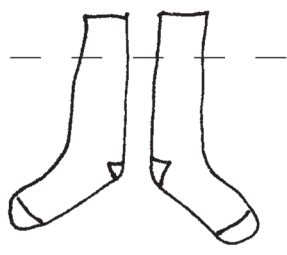
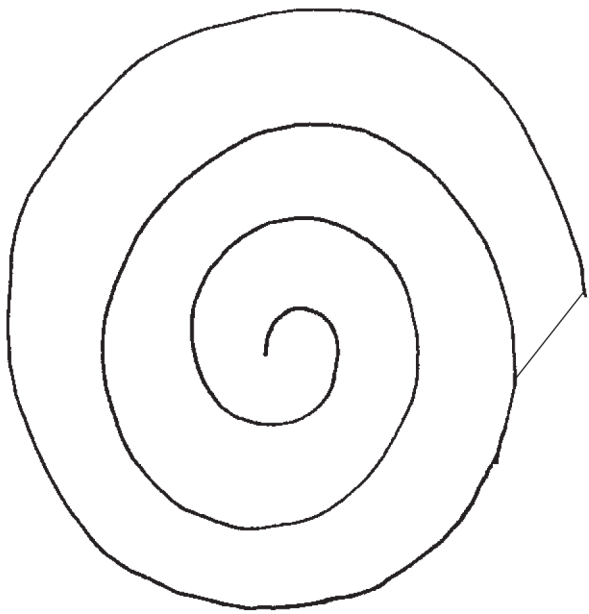

©Emily Martin

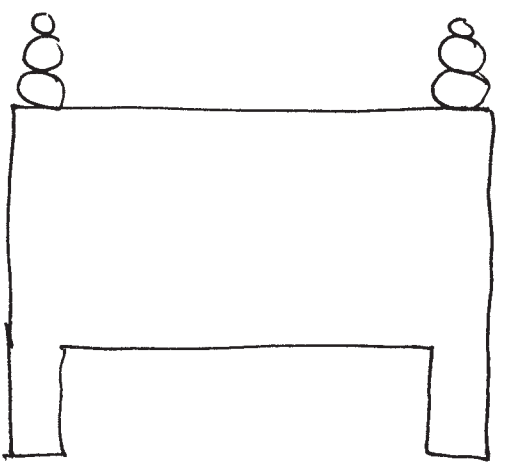
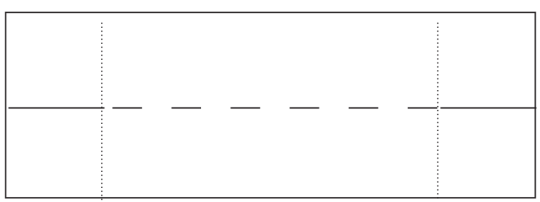
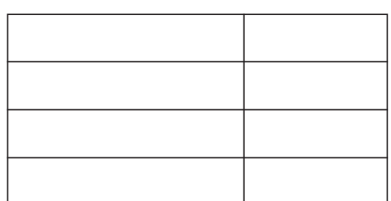
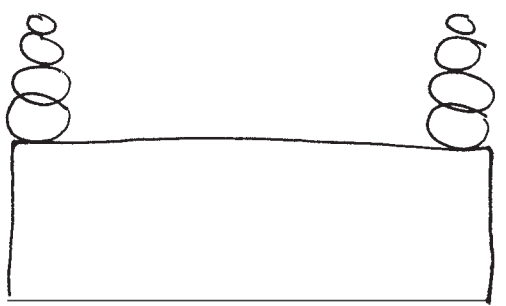
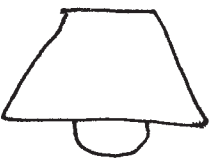
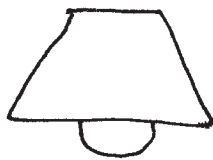
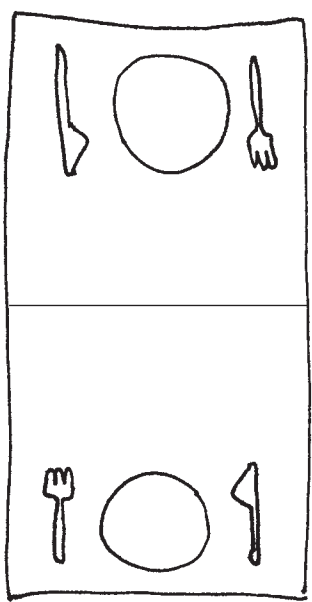
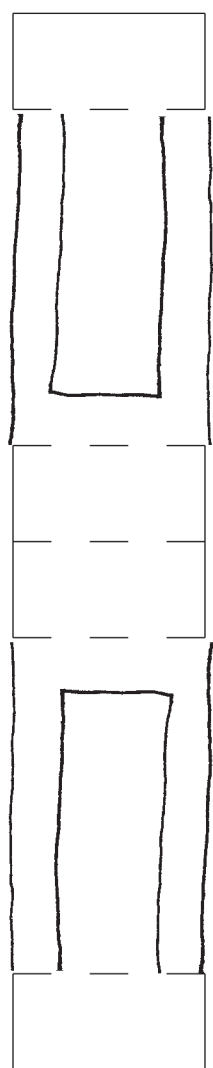
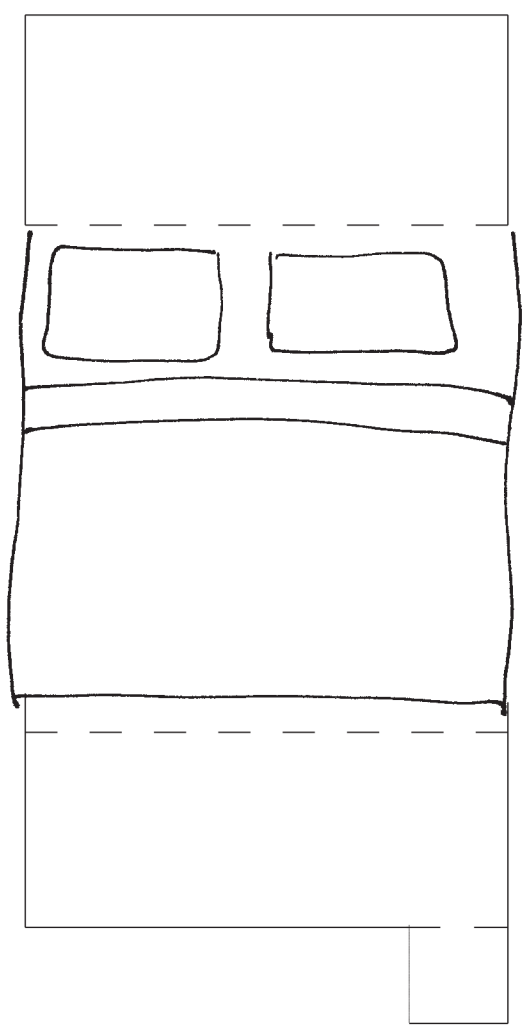
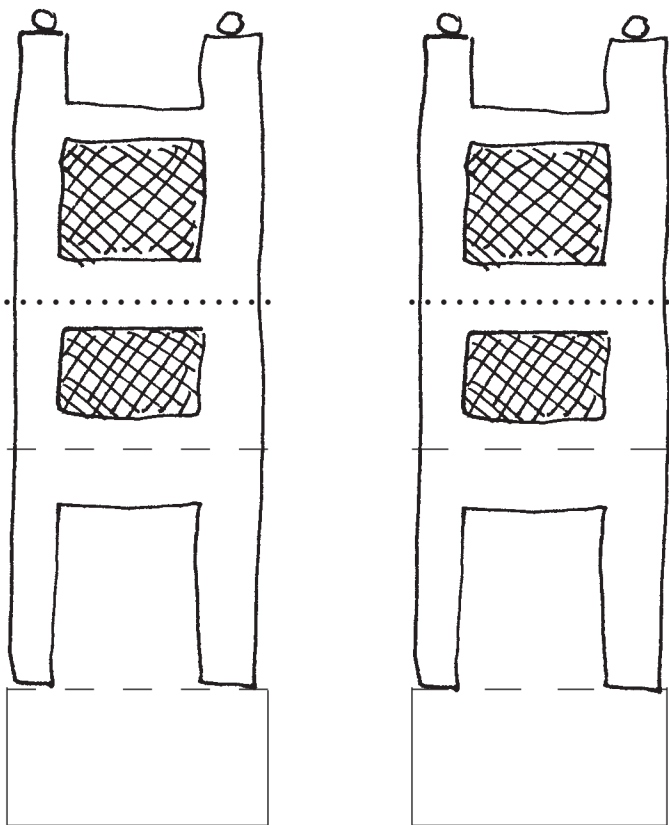

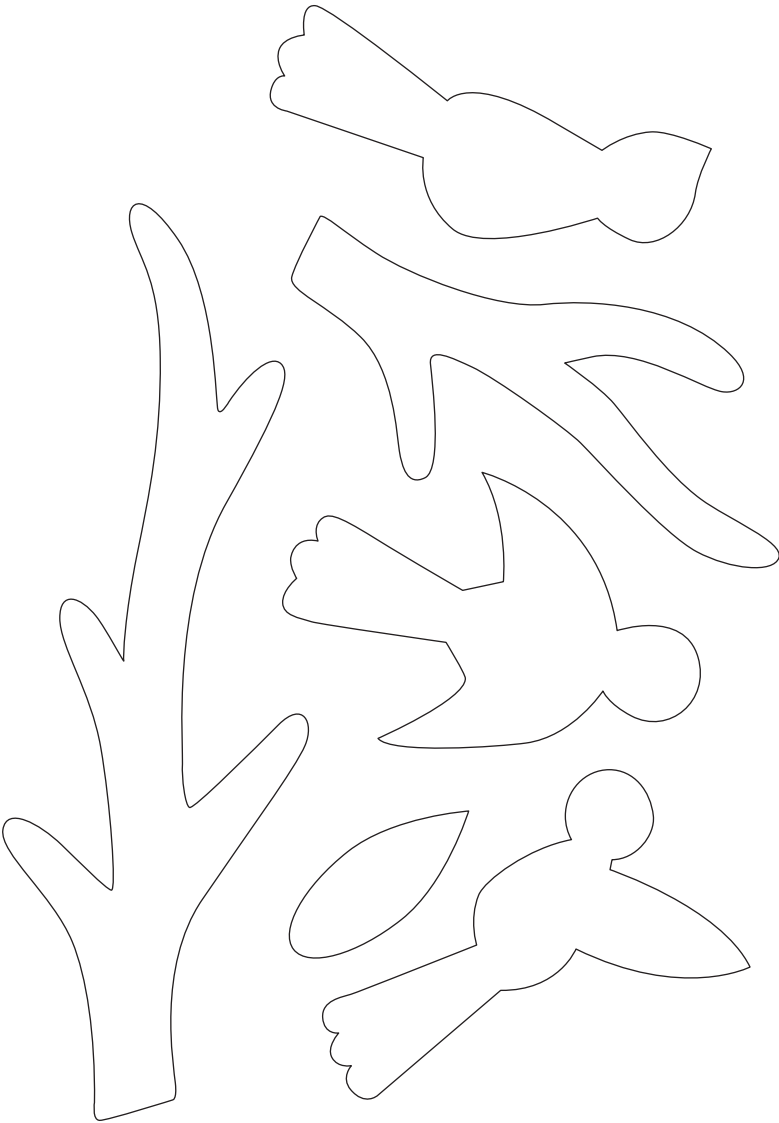

Puppy Puppet, page 81

©Mary Beth Cryan

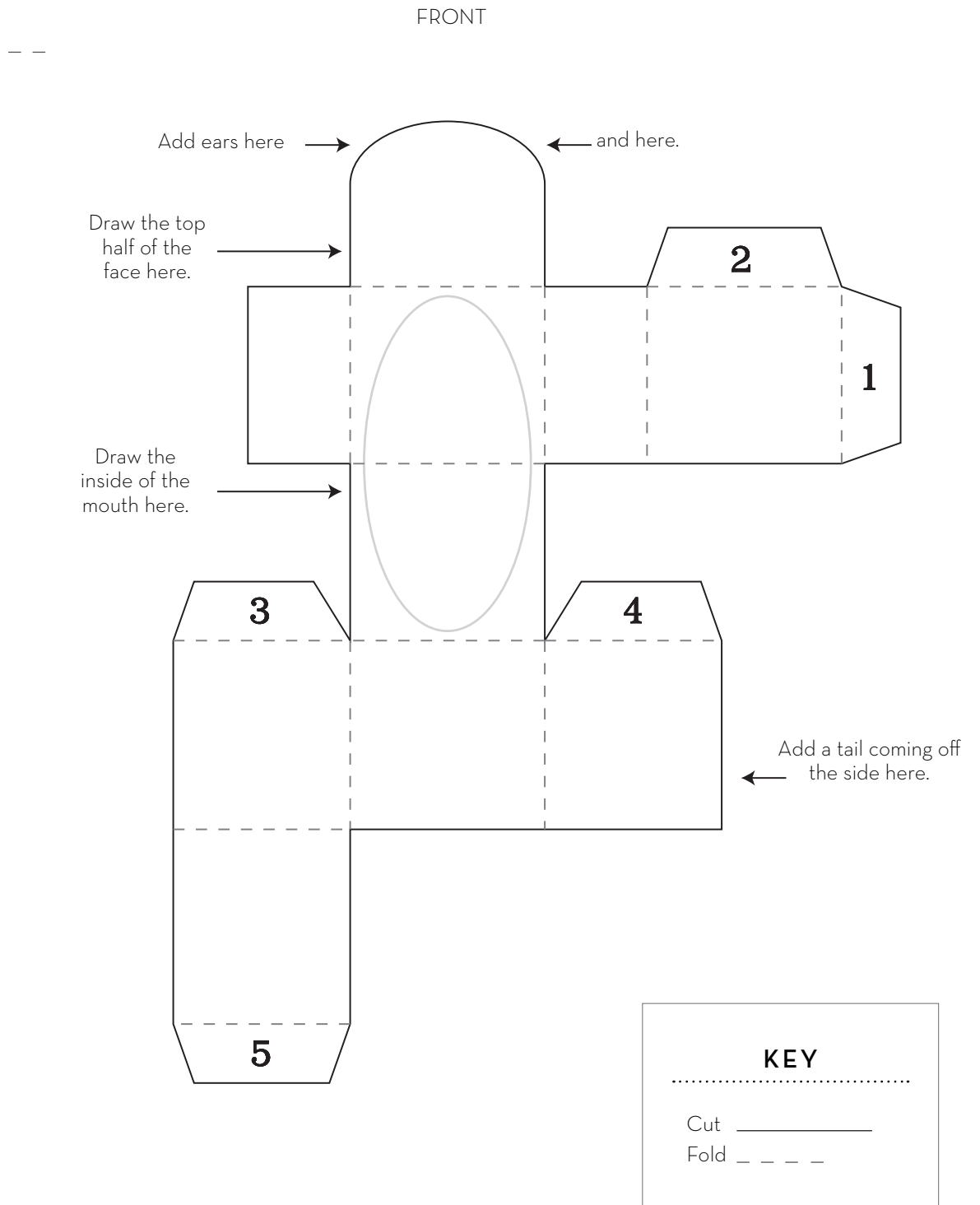

Puppy Puppet, page 81

©Mary Beth Cryan

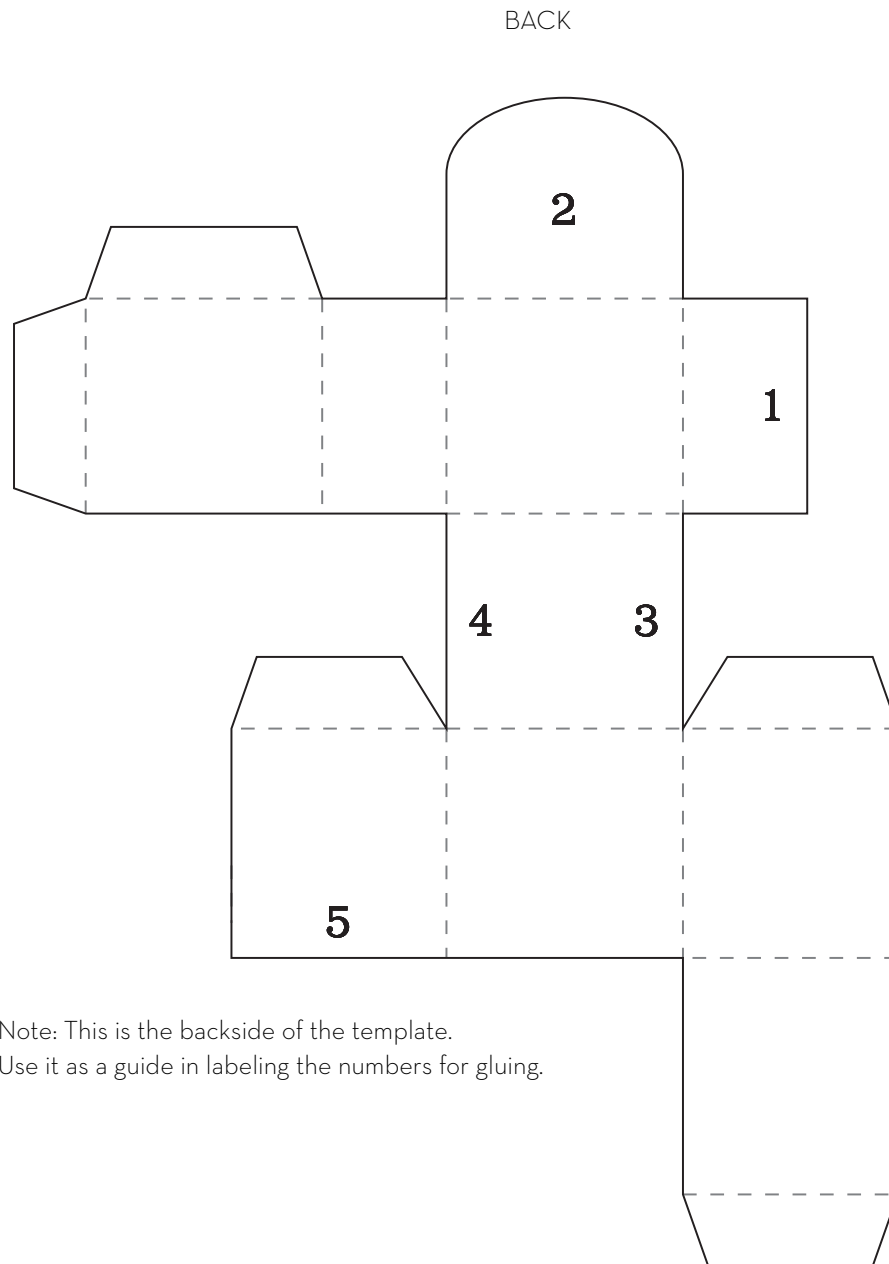

Note: This is the backside of the template.
Use it as a guide in labeling the numbers for gluing.

KEY	
.....	
Cut	—————
Fold	- - - - -

Pull-Tab Rib Cage, page 83

©Yoojin Kim

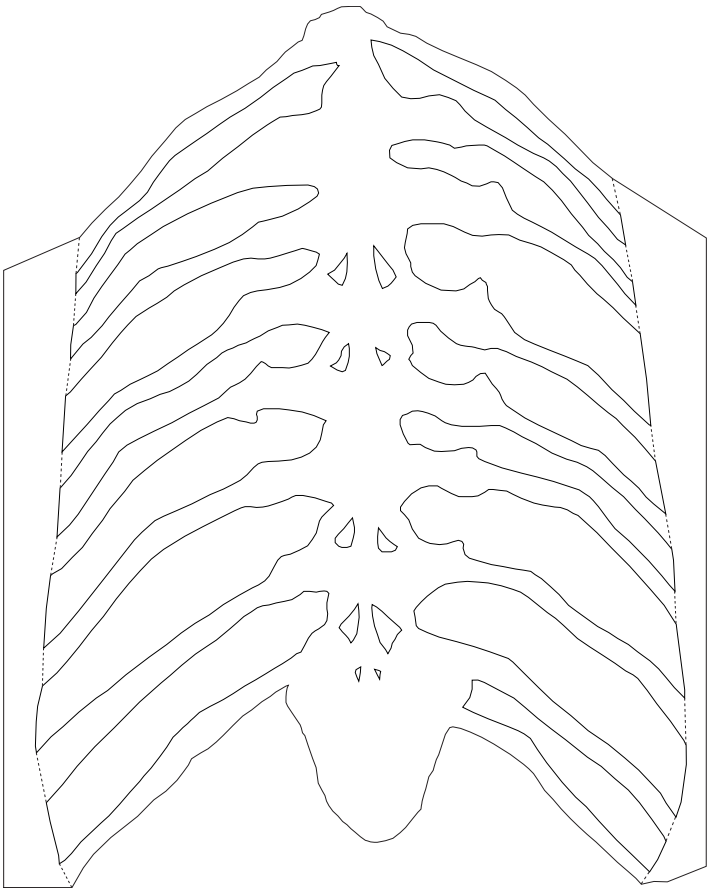

KEY

.....

Valley -----

Mountain -----

Cut _____

Pull-Tab Rib Cage, page 83

©Yoojin Kim

Figure 1 Base card

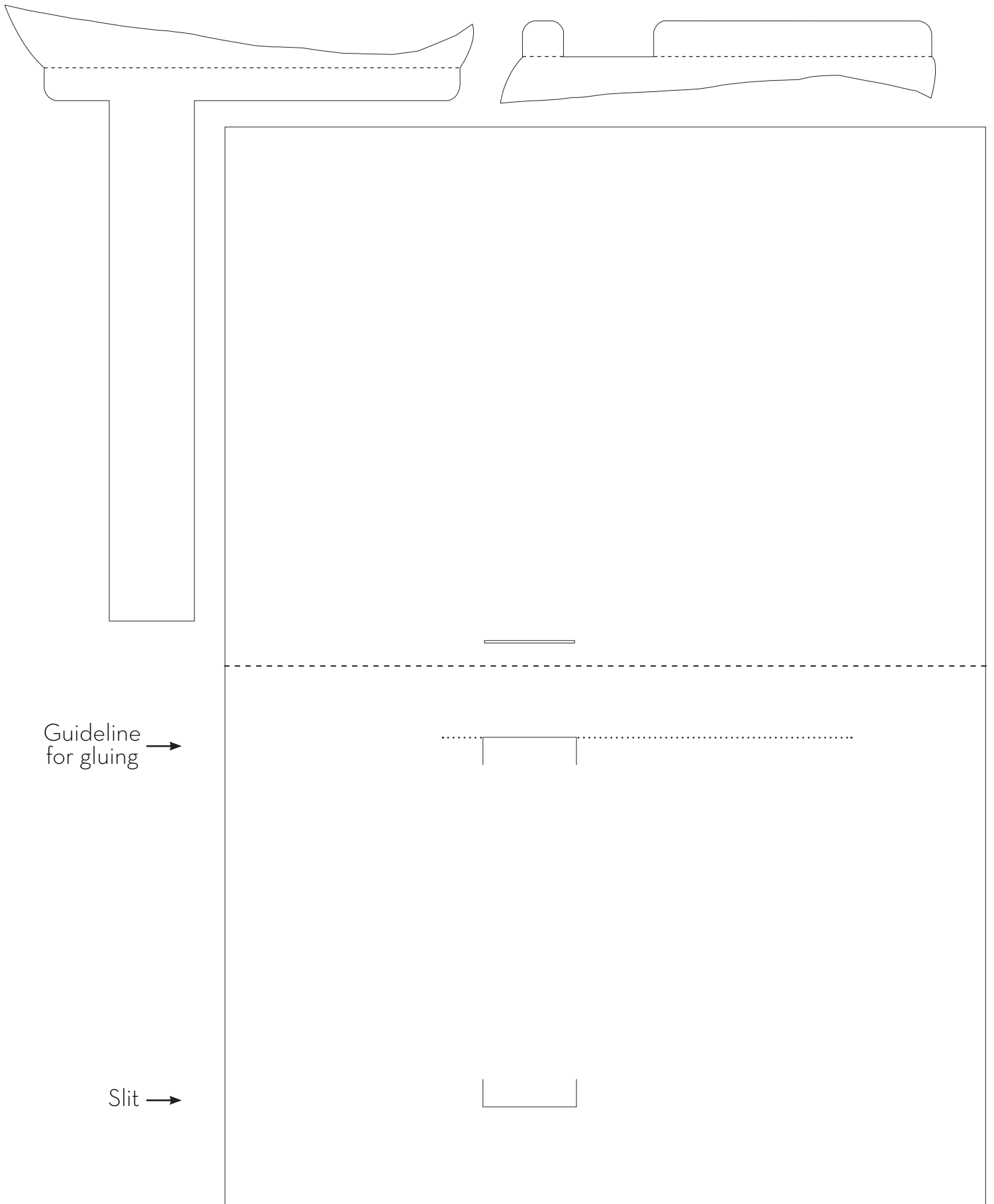

Volvelle with Six Slots (Part 1), page 85

©Julie Chen

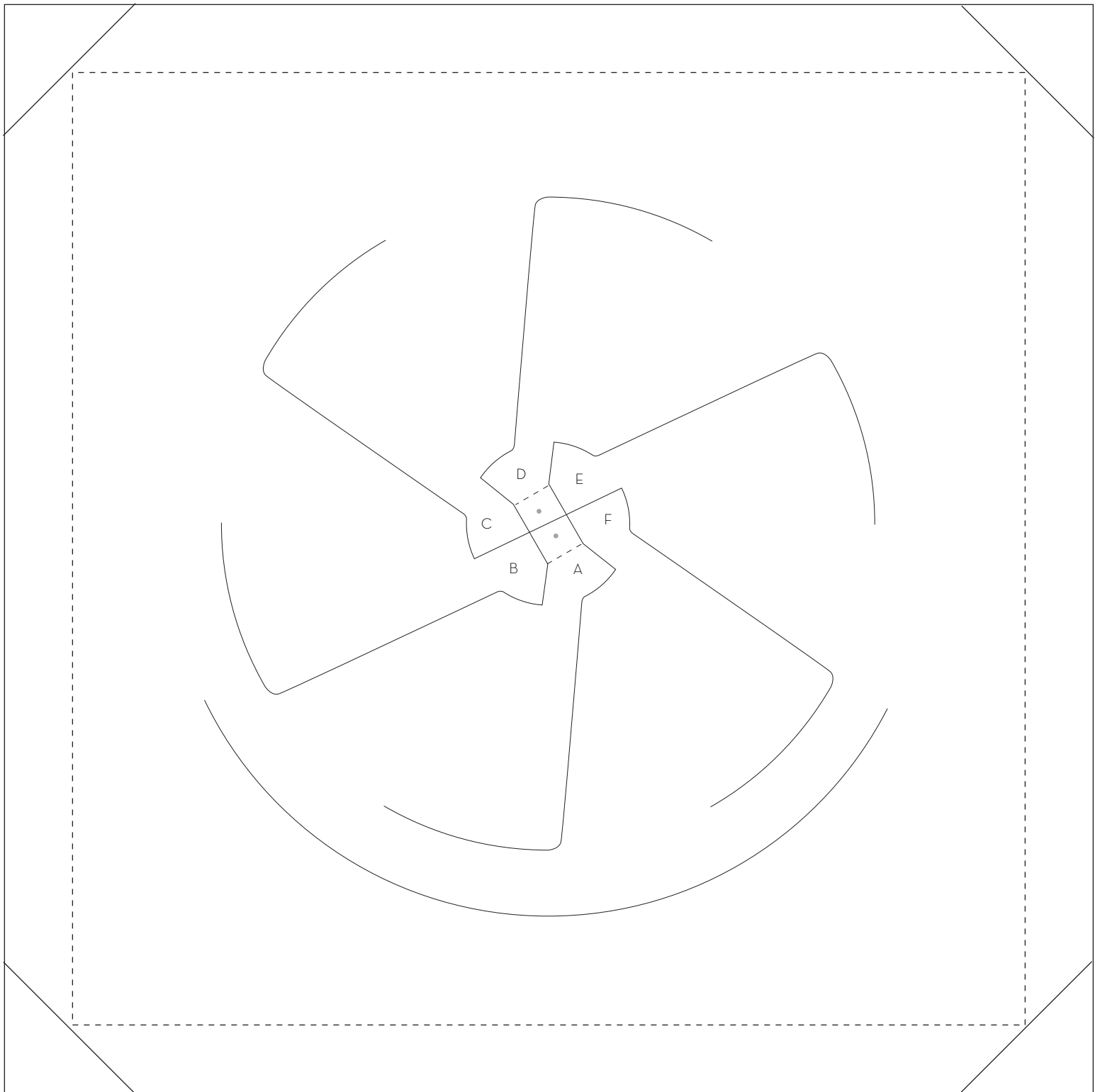

Note: All lines appear on the back side of the wheel.

KEY

.....

Cut _____

Fold

Volvelle with Six Slots (Part 2), page 85

©Julie Chen

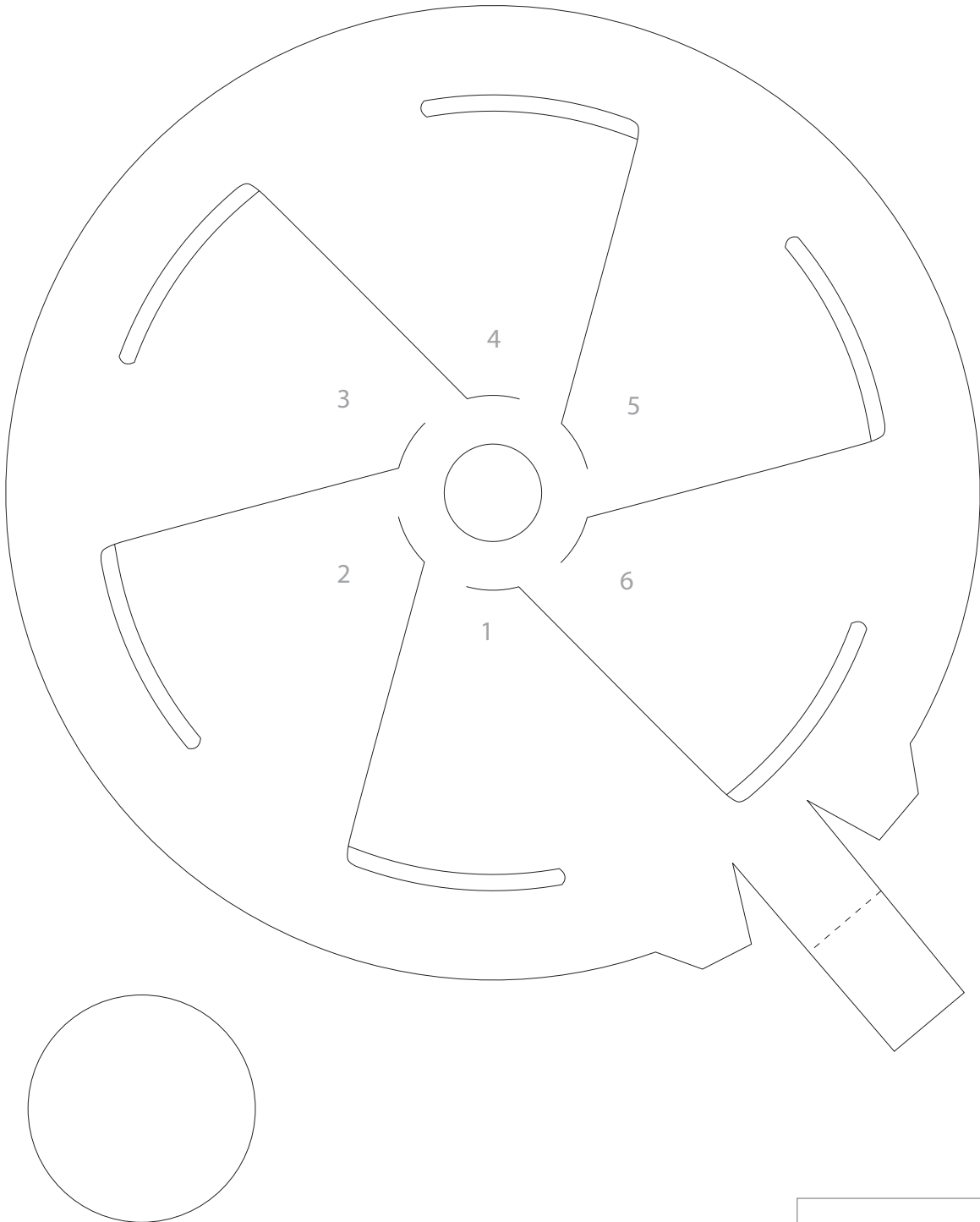

KEY

.....

Cut _____

Fold